

## Operating instructions

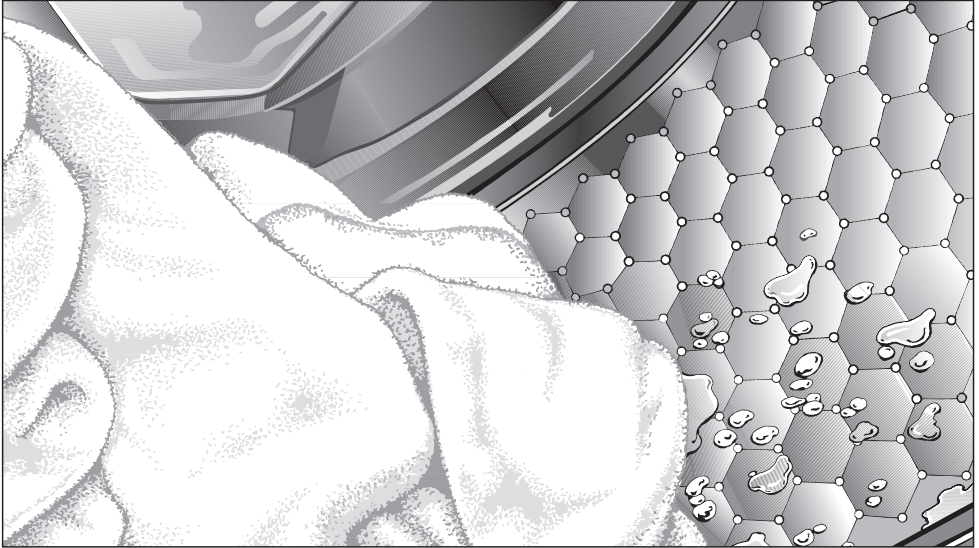

## for Washing machine W 3228

To avoid the risk of accidents or damage to the machine it is **essential** to read these instructions before it is installed and used for the first time.

en - GB

M.-Nr. 09 289 620

# Caring for our environment

---

## Disposal of the packing material

The transport and protective packing has been selected from materials which are environmentally friendly for disposal and should be recycled.

Ensure that any plastic wrappings, bags etc. are disposed of safely and kept out of the reach of babies and young children. Danger of suffocation!

## Disposal of your old machine

Electrical and electronic machines often contain materials which, if handled or disposed of incorrectly, could be potentially hazardous to human health and to the environment. They are, however, essential for the correct functioning of your machine. Please do not therefore dispose of it with your household waste.

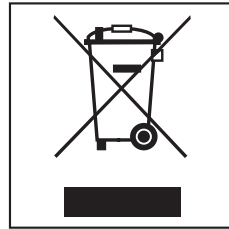

Please dispose of it at your local community waste collection / recycling centre or contact your Dealer for advice. Ensure that it presents no danger to children while being stored for disposal.

<b>Caring for our environment</b> .....	2
<b>Warning and Safety instructions</b> .....	6
<b>Description of the machine</b> .....	10
Control panel .....	10
<b>Before using for the first time</b> .....	12
<b>Washing environmentally and economically</b> .....	13
Energy and water consumption .....	13
Detergent .....	13
Choosing the correct additional option (Short, Soak, Pre-wash) .....	13
When drying with a tumble dryer .....	13
<b>How to wash correctly</b> .....	14
<b>Additional options</b> .....	19
Short .....	19
Pre-wash .....	19
Soak .....	19
Water plus .....	19
<b>Spinning</b> .....	20
Final spin speed .....	20
Rinse and interim spin .....	20
To omit the final spin (Rinse hold) .....	20
To omit rinse and interim spin and the final spin .....	20
<b>Delay start</b> .....	21
<b>Programme chart</b> .....	22
<b>Programme sequence</b> .....	24
<b>Garment care label symbols</b> .....	26

# Contents

---

<b>Changing the programme sequence</b> .....	27
Cancelling a programme .....	27
Interrupting a programme .....	27
Changing a programme .....	27
Skipping a programme stage .....	27
Adding or removing laundry after a programme has started .....	28
<b>Detergent</b> .....	29
The correct detergent .....	29
Water softeners .....	30
Washing with several components .....	30
Fabric conditioners and liquid starch .....	31
Automatic dispensing of fabric conditioner or liquid starch to laundry at the end of a programme .....	31
Adding fabric conditioner or starch separately .....	31
Colour run and dye removers / dyes .....	31
<b>Cleaning and care</b> .....	32
External casing and fascia panel .....	32
Extra cleaning .....	32
Cleaning the detergent dispenser drawer .....	32
Cleaning the water inlet filters .....	34
<b>Problem solving guide</b> .....	35
The programme does not start .....	35
The wash programme stops and a fault indicator light comes on. ....	36
A fault indicator light comes on but the wash programme continues as normal. .	37
General problems .....	38
An unsatisfactory wash result .....	39
The drum door does not open when you press the Door button. ....	40
Opening the drum door in the event of a blocked drain outlet and/or power failure. ....	41
Blocked drain outlet .....	41
<b>After sales service</b> .....	43
Future updates (PC) .....	43
Guarantee .....	43
Optional spare parts and accessories .....	43

<b>Installation and connection</b> . . . . .	44
Front view . . . . .	44
Rear view . . . . .	45
Installation surface . . . . .	46
Installing the washing machine . . . . .	46
Removing the transit bars . . . . .	46
Re-fitting the transit bars . . . . .	48
Levelling the machine . . . . .	49
Screwing out and adjusting the feet . . . . .	49
Building under a continuous worktop/in a kitchen run . . . . .	50
Washer and Dryer stack . . . . .	50
The Miele water protection system . . . . .	51
Connection to the water supply . . . . .	52
Connection to the drainage system . . . . .	53
Electrical connection U.K. . . . .	54
 <b>Consumption data</b> . . . . .	 55
 <b>Technical data</b> . . . . .	 56
 <b>Programmable functions</b> . . . . .	 58
Water plus system . . . . .	58
Gentle action . . . . .	59
Suds cooling for Cottons . . . . .	60
Memory function . . . . .	61
Soak duration . . . . .	62
 <b>Optional accessories</b> . . . . .	 63
CareCollection . . . . .	63

# Warning and Safety instructions

---

This washing machine conforms to current safety requirements. Inappropriate use can, however, lead to personal injury and damage to property.

To avoid the risk of accidents and damage to the washing machine, please read these instructions carefully before using it for the first time. They contain important information on its installation, safety, use and maintenance.

Keep these instructions in a safe place and ensure that new users are familiar with the content. Pass them on to any future owner.

## Correct application

► This washing machine is not designed for commercial use. It is intended for use in domestic households and in similar working and residential environments such as:

- Shops
  - Offices and showrooms
- and by residents in establishments such as

- Hostels and guest houses

► The washing machine is not intended for outdoor use.

► It must only be used as a domestic appliance to wash items which are specified by the manufacturer as being washable on the care label. Any other usage is not supported by the manufacturer and could be dangerous. Miele cannot be held liable for damage resulting from incorrect or improper use or operation of the washing machine.

► The washing machine can only be used by people with reduced physical, sensory or mental capabilities, or lack of experience and knowledge, if they are supervised whilst using it or have been shown how to use it in a safe way and understand the hazards involved.

## Safety with children

► Keep children away from the washing machine at all times. It is not a toy! To avoid the risk of injury do not allow children to play on or near it or to play with its controls. Supervise children whilst you are using it.

► Children 8 years and older may use the washing machine only if they have been shown how to use it in a safe way and understand the hazards involved.

► For machines with a 'porthole' door, remember that the porthole glass will be hot when washing at very high temperatures. Do not let children touch it.

# Warning and Safety instructions

---

## Technical safety

► Before setting up the washing machine, check it for any externally visible damage.

Do not install or use a damaged washing machine.

► Before connecting the washing machine, ensure that the connection data on the data plate (voltage and frequency) match the mains electricity supply. If in any doubt, consult a qualified electrician.

► The electrical safety of this washing machine can only be guaranteed when correctly earthed. It is most important that this basic safety requirement is observed and regularly tested, and where there is any doubt the household wiring system should be inspected by a qualified electrician. The manufacturer cannot be held liable for the consequences of an inadequate earthing system (e.g. electric shock).

► Do not connect the washing machine to the mains electricity supply by an extension lead. Extension leads do not guarantee the required safety of the appliance (e.g. danger of overheating).

► Faulty components must only be replaced by genuine Miele original spare parts. Only when these parts are fitted can the safety standards of the machine be guaranteed.

► Unauthorised repairs could result in unforeseen dangers for the user, for which Miele cannot accept liability. Repairs should only be undertaken by a Miele approved service technician.

► If the connection cable is faulty it must only be replaced by a Miele approved service technician to protect the user from danger.

► The machine must be isolated from the electricity supply in the event of a fault and during installation, maintenance and repair work.

► This washing machine must only be connected to the on-site water supply using a new hose kit. Old hoses must not be re-used.

► In areas which may be subject to infestation by cockroaches or other vermin, pay particular attention to keeping the machine and its surroundings in a clean condition at all times. Any damage which may be caused by cockroaches or other vermin will not be covered by the guarantee.

# Warning and Safety instructions

---

- ▶ This machine must not be used in a non-stationary location (e.g. on a ship).
- ▶ Do not make any alterations to the washing machine, unless authorised to do so by Miele.

## Correct use

- ▶ Do not install your washing machine in rooms where temperatures below freezing may occur. Frozen hoses may burst or split. The reliability of the electronic control unit may be impaired at temperatures below freezing point.
- ▶ Before using the washing machine for the first time, check that the transit bars at the rear of the machine have been removed (see section on "Installation and connection"). During spinning, a transit bar which is still in place may result in damage to both the machine and adjacent furniture or appliances.

- ▶ Turn off the stopcock if the machine is to be left for any length of time (e.g. holiday), especially if there is no floor drain (gully) in the immediate vicinity.
- ▶ Flooding danger.  
If hooking the drain hose into a wash basin, check that the water can drain off quickly enough to prevent the sink from overflowing. Make sure the drain hose is secure, so that the force of the water flowing out of the hose does not dislodge it.
- ▶ Take care to ensure that foreign objects (e.g. nails, pins, coins, paper clips) do not find their way into the machine with the laundry. These may damage components of the machine (e.g. suds container, drum), which in turn can result in damage to the laundry.



# Warning and Safety instructions

---

- ▶ If the correct amount of detergent is dispensed, the machine should not need to be descaled. If, however, you do wish to descale the machine only use proprietary non-corrosive descaling agents and strictly observe the instructions on the packaging. A special descaling agent is available to order from the Miele Spare Parts Department or via the internet at [www.miele-shop.com](http://www.miele-shop.com).
- ▶ Textiles which have been pre-treated with solvent based cleaning agents must be thoroughly rinsed in clean water before being washed in the machine.
- ▶ Do not use solvent based cleaning agents, e.g. those containing benzene, in this machine, as this may result in damage to component parts and create toxic fumes. Such agents also pose a fire and explosion hazard.
- ▶ Do not use solvent based cleaning agents, e.g. those containing benzene, to clean the outside surfaces of this machine. They can cause damage to plastic surfaces.
- ▶ Only use dyes specified by the manufacturer as being suitable for use in a domestic washing machine. Always observe the manufacturer's instructions carefully.
- ▶ Colour run and dye removers contain sulphur compounds which can cause damage such as corrosion. Do not use these products in this machine.
- ▶ If detergent comes into contact with the eyes, rinse them thoroughly with lukewarm water immediately. If swallowed, seek medical assistance immediately and retain the packaging or label for reference. Those with skin problems or sensitive skin should avoid their skin coming into contact with detergent.
- ▶ Only remove laundry from the washing machine once the drum has stopped turning. Reaching into a moving drum is extremely dangerous and could result in injury.

## Accessories

- ▶ Accessory parts may only be fitted when expressly approved by Miele. If other parts are used, guarantee, performance and product liability claims will be invalidated.

Miele cannot be held liable for damage caused by non-compliance with these Warning and Safety instructions.

# Description of the machine

## Control panel

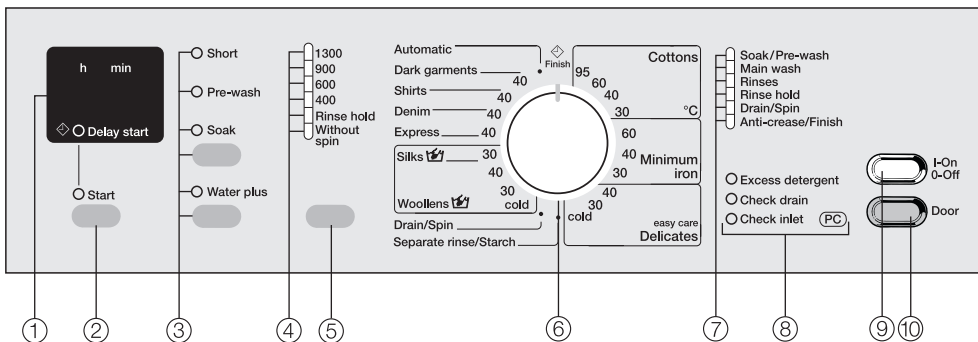

### ① Display

See the following page for more information

### ② Start button

- For delaying the start of a programme
- Starts the wash programme

### ③ Additional option buttons

Additional options can be added to the basic programme.

Use the top button to select either the *Short*, *Pre-wash*, or *Soak* option. Use the lower button to select the *Water plus* option.

Indicator light on = option selected  
Indicator light off = option not selected

### ④ Indicator lights for spin speed, Rinse hold or Without spin

### ⑤ Spin button

For selecting the final spin speed, Rinse hold or Without spin

### ⑥ Programme selector

For selecting the wash programme and temperature for that programme  
The programme selector can be turned clockwise or anti-clockwise.

### ⑦ Programme sequence indicator lights

Show which section of the wash programme has been reached

### ⑧ Check lights

### ⑨ I-On/0-Off button

For switching the machine on or off or interrupting a programme

### ⑩ Door button

Opens the machine door

## Display

The display shows:

- delay start
- programmable functions

## Delay start

The delay start time selected will appear in the display.

After the machine has started, the delay start time counts down. If the delay start time is more than 10 hours, it will count down by the hour. If it is less than 9 hours and 59 minutes it will count down minute by minute.

After the delay start time has elapsed, the programme begins and the display goes out.

## Programmable functions

The programmable functions can be used to tailor washing programmes to suit your individual requirements. In programming mode, the display will show the function selected.

## Before using for the first time

---

Before using the machine for the first time ensure that it is correctly installed and connected. See "Installation and connection". Also check that the drain filter is securely tightened. Otherwise there is a risk of water leakage during use.

This washing machine has undergone a thorough functional test in the factory and there will be some residual water in the drum from this process.

For safety reasons spinning is not possible until the machine has been prepared for using for the first time. To activate the spinning function you must run a wash programme without laundry and without detergent.

Using detergent could result in an excessive build-up of foam.

This also activates the ball valve. The ball valve prevents detergent escaping from the suds container into the sump during a wash programme, thus making maximum use of the detergent.

- Open the stopcock.
- Press the *I-On/O-Off* button in.
- Turn the programme selector to *Cottons 60°C*.
- Press *Start*.

When this programme has finished turn the programme selector to *Finish*. Your washing machine is ready for using for the first time.

# Washing environmentally and economically

---

## Energy and water consumption

- Water consumption and energy usage are determined by the size of the load.  
To make the most out of your machine, load the maximum dry load for the programme you are using.
- Use the *Automatic* and *Express* programmes for small loads.
- When smaller amounts of laundry are washed using the *Cottons* programmes, the automatic load recognition system will reduce the amount of water, time and energy used. This may mean that the time left shown in the display is adjusted during the course of the wash programme.
- Using the *Cottons 60°C* programme instead of the *Cottons 95°C* programme will give energy savings of between 35% and 45%. This is sufficient for most levels of soiling. For stubborn or old stains, use the *Soak* option.
- Use the additional option *Soak* instead of *Pre-wash*. If *Soak* is followed immediately by a main wash, the same suds are used.

## Detergent

- Do not exceed the amounts of detergent recommended by the manufacturer on the packaging.
- Reduce the amount of detergent with smaller loads (approx.  $\frac{1}{3}$  less than the amount recommended can be used when washing a half load).

## Choosing the correct additional option (Short, Soak, Pre-wash)

Select:

- A wash programme together with the *Short* option for light to normal soiling where there are no obvious marks.
- A wash programme without any additional options for normal to heavy soiling with visible staining.
- A wash programme together with the *Soak* option for heavily soiled laundry.
- The *Pre-wash* additional option for laundry with large amounts of dirt (e.g. dust, sand).

## When drying with a tumble dryer

Selecting the highest possible spin speed for the wash programme will save energy when drying in a tumble dryer afterwards.

# How to wash correctly

## Brief instructions

The headings numbered ①, ②, ③, . . . show the operating sequence and can be used as brief instructions.

### ① Sort the laundry

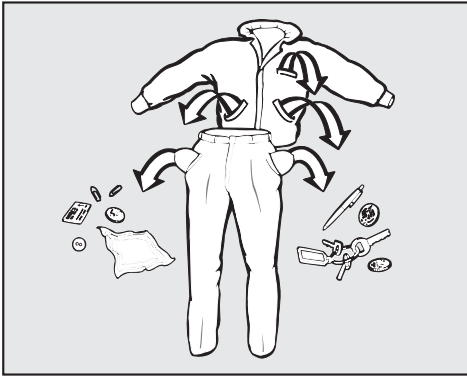

- Empty all pockets.

⚠ Foreign objects (e.g. nails, coins, paper clips, etc.) can cause damage to garments and components in the machine.

- Badly soiled areas, stains etc. should be cleaned as soon as possible, preferably whilst still fresh. Spillages should be carefully dabbed off using a soft colourfast cloth. Do not rub!

Badly soiled areas can be pre-treated with liquid detergent, stain removers etc. first, following the manufacturer's instructions. With particularly stubborn stains ask your dry cleaner for advice.

⚠ If you use a solvent-based cleaning agent (e.g. one containing benzene) to pre-treat a stain, make sure that any plastic parts (e.g. buttons) are protected, and that the cleaning agent is rinsed off before washing the garment in the machine.

⚠ Do not use solvent-based cleaning agents in or on this machine.

- Sort the laundry by colour and by care label. Most garments have a textile care label in the collar or side seam.

Dark textiles often contain excess dye and should be washed separately several times before being included in a mixed load. Always wash whites and coloureds separately.

- Curtains: Remove lead weights first or place in a laundry bag.
- Underwiring and collar stiffeners: Any loose wiring in bras, shirt collar stiffeners, etc. should be removed or sewn in.
- Knitted garments, trousers and jeans, T-shirts and sweat shirts: Turn inside out, if recommended by the manufacturer.
- Close any zips, fasten hooks and eyes etc before washing.
- Fasten duvet covers etc. to prevent small items from being rolled up inside them.

Do not wash any items in this machine which are specified by the manufacturer as **not washable** on the care label. (☒ symbol)

# How to wash correctly

## 2 Switch on the washing machine

### 3 Load the drum

- Press the *Door* button to open the drum door.
- Unfold the laundry and load loosely into the drum. Mixing both large and small items gives better wash results and also helps distribute the load evenly during spinning.

The most efficient use of energy and water is achieved when a full load is washed. However, do not overload as this causes creases and reduces cleaning efficiency.

Make sure that no items are caught between the drum door and seal.

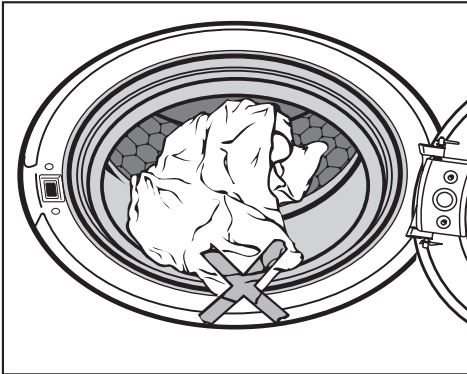

- Shut the door with a gentle swing.

## 4 Select Delay start (if required)

Make sure that the programme selector is at the  *Finish* position.

- Press the *Start* button to set the delay start time.

## 5 Select a programme

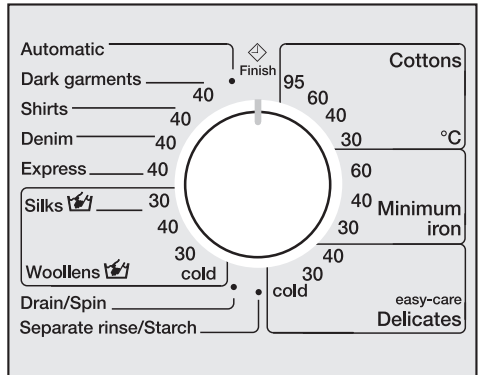

- Turn the programme selector to the required programme.

If Delay start has not been selected, the display is now dark.

# How to wash correctly

## 6 Select additional option(s)

Each press of the top button selects the additional options in the following order: *Short*, *Pre-wash*, *Soak* or no option.

Use the lower button to select the *Water plus* option.

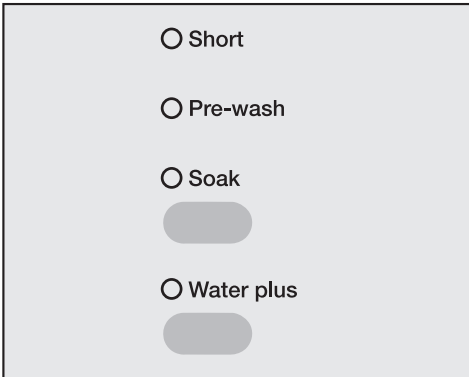

- Select the option(s) you want.

Not all the additional options are suitable for every programme.

You can only select additional options which are compatible with the basic programme being used.

## 7 Select a spin speed

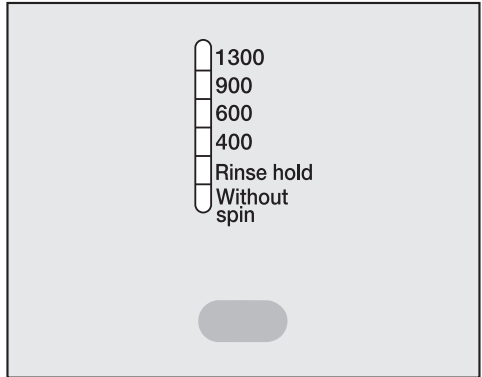

- Press the "Spin" button repeatedly until the indicator light for the spin speed you want comes on.



# How to wash correctly

## 8 Add detergent

It is important to dispense the correct amount, because . . .

. . . too little detergent results in:

- Laundry not getting properly clean and in time becoming grey and hard to the touch.
- Greasy particles clinging to the laundry.
- Limescale deposits on the heater elements.

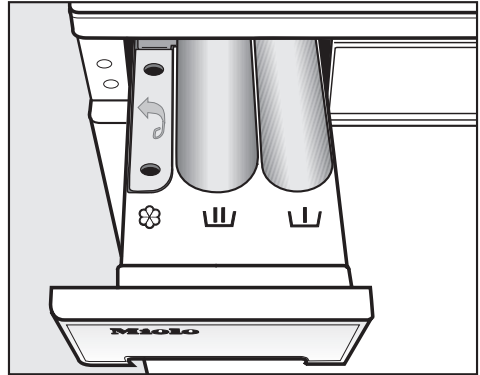

. . . too much results in:

- Excessive foam which causes a low level of agitation and poor wash, rinse and spin results.
- Higher water consumption (an additional rinse cycle will automatically switch in).
- A burden to the environment.



- Pull out the detergent drawer and place detergent in the compartments as follows:



Detergent for the pre-wash (divide the total recommended amount as follows: add  $\frac{1}{3}$  to compartment  and  $\frac{2}{3}$  to compartment .



Detergent for the main wash, including Soak if selected



Fabric conditioners or liquid starch

- Close the detergent drawer.

See "Detergent" for further information.

# How to wash correctly

## 9 Start the programme

- Press the flashing *Start* button.

If a delay start time has been selected, then this will count down in the display. After the Delay start time has elapsed, the display goes out and the programme starts.

## 10 Unload the drum

When the programme has finished, the *Anti-crease/Finish* indicator light will come on.

- Press the *Door* button to open the drum door.
- Remove the laundry.

Check that all items have been removed from the drum. Items left in the drum could discolour other items in the next wash or become discoloured themselves.

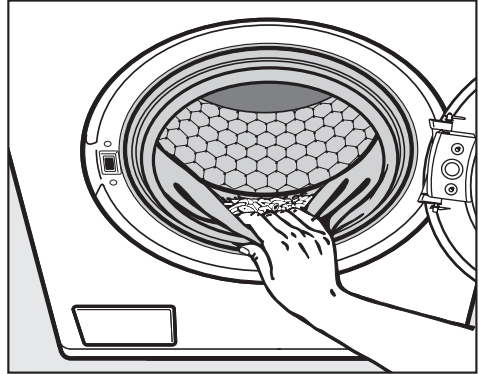

- Check the folds in the door seal for any small articles, e.g. buttons, which might be lodged there.
- Press and release the *I-On/O-Off* button, and turn the programme selector to  *Finish*.
- Close the drum door. Otherwise there is the danger of objects being placed inadvertently in the drum. If these remained unnoticed and were washed in the next load, they could damage the laundry.

You can use the additional option buttons to augment the wash programmes.

### Short

For light to normal soiling with no visible staining.

The duration of the main wash is reduced.

In the *Dark garments* and *Denim* programmes, 2 rinses will be carried out instead of 3.

### Pre-wash

For laundry with large amounts of dirt e.g. dust, sand.

### Soak

For heavily soiled and stained items with protein stains (e.g. blood, fats and oils, cocoa).

- A length of time of between 30 minutes and 2 hours can be programmed in 30 minute increments for the soak process.
- The default setting is 2 hours.

To programme in a different soak period see "Programmable functions – Soak".

### Water plus

If you want to increase the water level for a wash process you can choose one of four settings for the *Water plus* button. See "Programmable functions - Water plus system".

The machine is set at the factory so that the water level in the main wash and rinses will be increased if the *Water plus* button is pressed.

# Spinning

## Final spin speed

Programme	rpm
Cottons	1300
Minimum iron	1200
Delicates	600
Automatic	900
Dark garments	1200
Shirts	600
Denim	900
Express	1300
Silks	400
Woollens	1200
Drain/Spin	1300
Separate rinse/Starch	1200

You can reduce the final spin speed. However, you cannot select a final spin speed higher than that shown in the chart above.

## Rinse and interim spin

There is a spin after the main wash and between the rinses. A reduction in the final spin speed will also reduce the interim spin speed. If a spin speed of less than 700 rpm is selected for a *Cottons* programme, an additional rinse is introduced.

## To omit the final spin (Rinse hold)

■ Select the *Rinse hold* setting. The laundry will not be spun and will remain suspended in the final rinse water. This reduces creasing if the laundry is not going to be removed from the drum immediately after the end of the programme.

– To start the final spin:

The *Rinse hold* indicator light above the "Spin" button will be lit up. Use the "Spin" button to select the spin speed you want. The final spin will then begin.

– To end the programme:

Press the *Door* button. The water will drain away. Press the *Door* button again to open the door.

## To omit rinse and interim spin and the final spin

■ Select the *Without spin* setting. The laundry is not spun after the final rinse. The water will drain away and the machine will go straight into the anti-crease stage. An additional rinse is introduced if this setting is selected with the *Cottons*, *Minimum Iron* and *Automatic* programmes.

With Delay start you can choose when you want the programme to start. The start of a programme can be delayed from 30 minutes up to a maximum of 24 hours, allowing you to make use of night-time economy electricity rates, for example.

## To select Delay start

Make sure that the programme selector is at the  *Finish* position.

The  *Delay start* indicator will flash in the display.

You can now use the *Start* button to enter the delay start time you want.

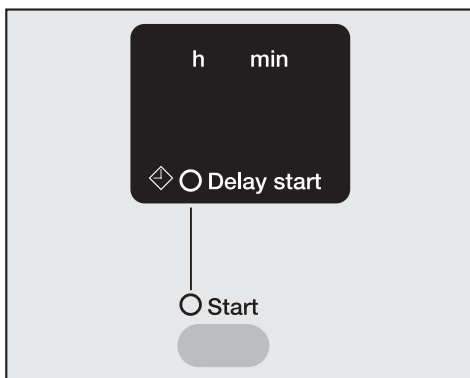

■ Press the *Start* button. Each press on the button increases the delay start time:

- in 30 minute steps up to 10 hours,
- in 1 hour steps from 10 hours upwards.

If you keep the *Start* button pressed in, the time will continue to count up to 24 hours.

## To alter Delay start

It is not possible to alter the Delay start time after the programme has been selected.



















## To cancel Delay start

Press the *Start* button again when *24 h* is showing in the display.







## To cancel Delay start after you have pressed the *Start* button:

You will have to cancel the programme. See "Changing the programme sequence".

# Programme chart

<b>Cottons 30°C to 95°C</b>     <sup>1)</sup>		<b>Max. load 7.0 kg</b>
Use for	Cotton, linen or cotton mix fabrics.	
Additional options	Short or Pre-wash or Soak, Water plus	
<b>Note for test institutes:</b>		
The test programme conforms to EN 60456 and the energy label with Directive 1061/2010.		
<b>Minimum iron<sup>2)</sup> 30°C to 60°C</b>       <sup>1)</sup>		<b>Max. load 3.0 kg</b>
Use for	Synthetic and mixed fibre garments as well as easy care cotton. Reduce the spin speed for fabrics which crease easily.	
Additional options	Short or Pre-wash or Soak, Water plus	
<b>Delicates cold to 40°C</b>     <sup>1)</sup>		<b>Max. load 2.0 kg</b>
Use for	Delicate garments made of synthetic fibres, mixed fibres, rayon and easy care cotton. Curtains, including net curtains, specified as machine-washable by the manufacturer.	
Additional options	Short or Pre-wash or Soak	
Notes	<ul style="list-style-type: none"> <li>– Dust in curtains usually makes using a programme with Pre-wash advisable.</li> <li>– For curtains which crease easily, reduce the spin speed or select Without spin.</li> </ul>	
<b>Automatic 40°C</b>   <sup>1)</sup>		<b>Max. load 3.5 kg</b>
Use for	Mixed loads of garments suitable for the <i>Cottons</i> and <i>Minimum iron</i> programmes. Sort according to colour.	
Additional options	Short or Pre-wash or Soak, Water plus	
<b>Dark garments<sup>2)</sup> 40°C</b>   <sup>1)</sup>		<b>Max. load 3.0 kg</b>
Use for	Dark garments made from cotton or mixed fibres.	
Additional options	Short or Pre-wash or Soak	
Note	Wash inside out.	





















## Programme chart

<b>Shirts 40°C</b>		<b>Max. load 2.0 kg</b>
Additional options	Pre-wash or Soak	
Notes	<ul style="list-style-type: none"> <li>– Pre-treat collars and cuffs if necessary.</li> <li>– Wash silk garments in the <i>Silks</i> programme.</li> </ul>	
<b>Denim 40°C</b>		<b>Max. load 3.0 kg</b>
Additional options	Short or Pre-wash or Soak	
Notes	<ul style="list-style-type: none"> <li>– Wash denim inside out.</li> <li>– Denim often contains excess dye and may run during the first few washes. Wash light and dark coloured items separately.</li> </ul>	
<b>Express 40°C</b>   <sup>1)</sup>		<b>Max. load 3.0 kg</b>
Use for	Small loads of items which require freshening up and which can be washed in a <i>Cottons</i> programme.	
<b>Silks</b>  <b>30°C</b>  <sup>1)</sup>		<b>Max. load 1.0 kg</b>
Use for	Silks and other handwashable fabrics with no wool content, e.g. satin, lace and silk.	
Additional option	Water plus	
Note	Place socks, tights, bras etc. in a washing bag.	
<b>Woollens<sup>2)</sup></b>  <b>cold to 40°C</b>   <sup>1)</sup>		<b>Max. load 2.0 kg</b>
Use for	Machine-washable or hand-washable wool or wool blend fabrics. If the care label does not specify a temperature, wash using the cold setting.	
<b>Drain/Spin</b>		<b>Max. load 6.0 kg</b>
Notes	Make sure you select the appropriate spin speed. Drain only: Select <i>Without spin</i> .	
<b>Separate rinse/Starch<sup>2)</sup></b>		<b>Max. load 6.0 kg</b>
Note	When using starch, laundry should be washed but not treated with fabric conditioner.	

<sup>1)</sup> Please note that the "buckets" represent garment care label symbols. See "Garment care label symbols".

<sup>2)</sup> During the final spin the 1300 rpm indicator light will come on. However, to protect the laundry, the machine will only spin at 1200 rpm during this spin.

## Programme sequence

	Main wash		Rinses		Spinning	
	Water level	Wash rhythm	Water level	Rinses	Interim spin	Final spin
Cottons		Ⓐ		2-4 <sup>1)</sup>	✓	✓
Minimum iron		Ⓐ		2-3 <sup>2)</sup>	✓	✓
Delicates		Ⓑ		3	–	✓
Automatic		Ⓐ		2-3 <sup>2)</sup>	✓	✓
Dark garments		Ⓐ		3	✓	✓
Shirts		Ⓐ		2	–	✓
Denim		Ⓐ		3	–	✓
Express		Ⓐ		2	✓	✓
Silks		Ⓓ		2	–	✓
Woollens		Ⓒ		2	✓	✓
Drain/Spin	–	–	–	–	–	✓
Separate rinse/Starch	–	–		1	–	✓

 = Low water level

 = Medium water level

 = High water level

Ⓐ = Normal wash rhythm

Ⓑ = Gentle action

Ⓒ = Woollens

Ⓓ = Silks

See the following page for more information about the programme sequences.



This washing machine has fully electronic controls with automatic load recognition. It takes in the right amount of water required for the programme depending on the amount of laundry and its absorbency rate. This means that programme cycles and durations can vary.

The programme sequences outlined in the chart are based on the basic programme with a full load. Additional options which can be selected have not been taken into account.

The programme sequence display shows the stage the programme has reached.

## **Special features in the programme sequences:**

### Anti-crease:

At the end of every programme, with the exception of the *Woolens* programme, the drum continues to turn at intervals for up to 30 minutes to help prevent creasing. The door can be opened and laundry removed at any time during the anti-crease phase.

- 1) A second rinse is carried out when a temperature between 60°C and 95°C has been selected. A third rinse is carried out when a temperature below 60°C is selected.





### A third/fourth rinse is carried out if:



- there is too much foam in the drum
- a spin speed lower than 700 rpm has been selected
- Without spin has been selected





- 2) A third rinse is carried out if:





Without spin has been selected



# Garment care label symbols

Washing	
The figure quoted in the bucket is the maximum temperature the garment can be washed at. The number of bars under the symbol indicate the level of agitation permitted.	
	No bar under the symbol: = normal agitation
	One bar under the symbol: = reduced agitation
	Two bars under the symbol: = much reduced agitation
	Hand wash (if no temperature is specified use the lowest temperature or cold)
	Do not wash

Drying	
The number of dots indicates the drying temperature	
	Normal temperature
	Low temperature
	Do not tumble dry

Ironing	
The number of dots indicates the ironing temperature	
	Hot iron (max sole plate temp. approx. 200°C)
	Medium hot iron (max sole plate temp. approx. 150°C)
	Cool iron (max sole plate temp. approx. 110°C). Do not steam iron garments carrying this symbol.
	Do not iron

Professional cleaning	
	Dry clean only. The letters indicate the type of cleaning agent required.
	
	Professional Wet Clean only
	Do not dry clean

Bleaching	
	Any oxidising bleaching agent can be used
	Only use an oxygen based bleach or a non-chlorine bleach
	Do not bleach

# Changing the programme sequence

---

## Cancelling a programme

You can cancel a programme at any time after it has started.

- Turn the programme selector to  *Finish*.

The programme has been cancelled when the *Anti-crease/Finish* indicator light comes on (this can take up to 30 seconds).

If you want to select a different programme:

- Switch the machine off and then back on again with the *I-On/O-Off* button.
- Check that there is still detergent in the detergent drawer. Add detergent, if necessary.
- Select and start a new programme.

If you want to remove the laundry:

- Turn the programme selector to *Drain/Spin*. Make sure the spin speed is appropriate for the laundry.
- Press the *Start* button.

The suds will be pumped away.

- Press the *Door* button.

## Interrupting a programme

- Switch the machine off with the *I-On/O-Off* button.

To continue with the same programme:

- Switch the machine on with the *I-On/O-Off* button.

## Changing a programme

After the start of a programme it is no longer possible to select a different programme.

### Temperature

It is possible to select a different temperature up to 6 minutes after the programme has started.

### Spin speed

It is possible to change the spin speed at any time.

### Additional options

It is possible to select or deselect the *Water plus* additional option up to 6 minutes after the programme has started.

## Skipping a programme stage

- Turn the programme selector to  *Finish*.

As soon as the programme sequence indicator light for the programme stage you want the programme to continue at starts flashing:

- Turn the programme selector back to the appropriate programme again within 4 seconds.

# Changing the programme sequence

---

## **Adding or removing laundry after a programme has started**

- Press the *Door* button in until the drum door springs open.
- Add or remove items.
- Close the door.

The programme will continue automatically.

The door cannot be opened, if:



- the suds temperature is above 55°C.
- the water is above a certain level.
- the programme has reached the *Final spin* stage.

## The correct detergent

All modern detergents produced for automatic washing machines are suitable. Use dispensing aids, e.g. balls, if these are supplied with the detergent. Tablets are suitable for full loads but note that it may be impractical to reduce tablets for smaller loads. Some tablets do not dissolve as rapidly as others and may not be suitable for programmes with short durations.

Do not use biological detergents on silk as the enzymes may damage the silk! Instructions for use and recommended amounts for a full load are given on the detergent packaging.

Liquid detergent should be dispensed using a ball provided by the manufacturer for programmes without a pre-wash.

For programmes with a pre-wash you will need to purchase a special container from the Miele Spare Parts department which sits in the main wash compartment  of the detergent dispenser drawer. Add liquid detergent to this container for the main wash and to compartment  for the pre-wash.

See "Optional accessories" at the end of this booklet for details of Miele branded care products, including detergents and fabric conditioners.

	<b>Universal detergent</b>	<b>Detergent for coloureds</b>	<b>Detergent for delicates</b>
Cottons	X	X	
Minimum iron	X	X	
Delicates			X
Automatic	X	X	
Dark garments		X <sup>1)</sup>	
Shirts	X	X	
Denim		X <sup>1)</sup>	
Express	X	X	
Silks	Liquid detergent for machine-washable silk and woollens		
Woollens	Liquid detergent for machine-washable woollens		
Separate rinse/Starch	Liquid starch, starch formulations, viscous liquid starch, fabric conditioner		

<sup>1)</sup> Only use liquid detergent

# Detergent

---

## The right amount to dispense will depend on the following:

- The quantity of laundry.
- The soiling level of the laundry.

### Lightly soiled

No visible dirt or stains. Possibly slight body odour.

### Normally soiled

Visibly dirty and/or just a few slight stains.

### Heavily soiled

Visible dirt and stains and/or dried on soiling.

- The water hardness level.  
Check with your local water supplier if you do not know the hardness level in your area.

## Water hardness levels

Hardness scale	Hardness level mmol/l	German °d
I (soft)	0 - 1.5	0 - 8.4
II (medium)	1.5 - 2.5	8.4 - 14
III (hard)	Above 2.5	Above 14

## Refill packs of detergent

When purchasing detergent buy refill packs wherever possible. This helps reduce the amount of waste packaging.

## Water softeners

A water softener can be used to cut down on the use of detergents in hard water areas. Dispense according to the amount specified on the packaging. First add detergent and then the water softener.

Miele branded water softening tablets are available from the Miele Spare Parts Department or via the internet at [www.miele-shop.com](http://www.miele-shop.com)

Use a quantity of detergent as for soft water.

## Washing with several components

If you wash using several components (e.g. special application detergents), we recommend always dispensing the agents into compartment  in the following order:

1. Detergent
2. Water softener
3. Stain remover

This way the agents are distributed more evenly.

## Fabric conditioners and liquid starch

Fabric conditioners make garments soft to handle and help prevent static cling when tumble drying.

Starch stiffens and gives body to items of laundry, e.g. shirts, tablecloths and bed linen.

### Automatic dispensing of fabric conditioner or liquid starch to laundry at the end of a programme

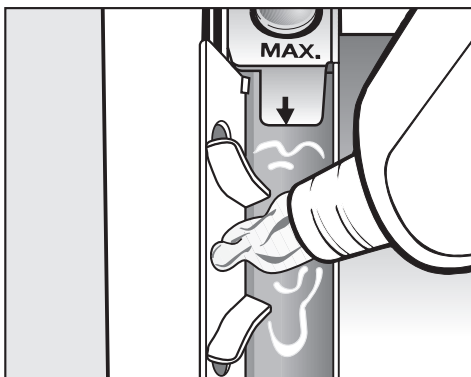

- Add the fabric conditioner or liquid starch to compartment ⌘. **Do not exceed the maximum level mark.**

It will be automatically dispensed in the last rinse. At the end of the programme a small amount of water remains in the fabric conditioner compartment ⌘.

If starching frequently, the dispenser compartment and especially the siphon tube and fabric conditioner channel will need regular cleaning to remove any residual starch. See "Cleaning the detergent dispenser drawer". Do not add powder starch formulations or viscous liquid starch to the ⌘ compartment as it will clog up. See below.

### Adding fabric conditioner or starch separately

- Dispense in accordance with manufacturer's instructions on the packaging.
- Add powder or viscous starch to compartment U.
- Add the fabric conditioner or liquid starch to compartment ⌘.
- Turn the programme selector to *Separate rinse/Starch*
- Select a spin speed.
- Press the *Start* button.

### Colour run and dye removers / dyes

- Do not use colour run or dye removers in this washing machine.
- Dyes suitable for use in domestic washing machines can be used. However, please note that the salt used in the dyeing process can cause corrosion to stainless steel components in the machine if you dye frequently. Always observe the manufacturer's instructions carefully.

## Cleaning and care

 Disconnect the machine from the mains electricity supply and withdraw the plug from the socket before cleaning the machine.

 The washing machine must not be hosed down.

A range of Miele branded cleaning and conditioning agents is available to order from the Miele Spare Parts Department, or via the internet on [www.miele-shop.com](http://www.miele-shop.com).

### External casing and fascia panel

Clean the casing using a Miele E-Cloth, or with a mild, non-abrasive cleaning agent or soap and water using a well wrung-out cloth. Wipe dry with a soft cloth.

- The drum and any stainless steel outer panels can be cleaned using a suitable stainless-steel cleaning agent following the instructions on the packaging.

 Do not use solvents, abrasive cleaners, glass cleaners or all-purpose cleaning agents. These could damage plastic surfaces and other parts.

### Extra cleaning

Carry out a hot wash (60°C or above) with powder detergent approx. every 6 weeks to help prevent deposits building up in the machine. These can occur when washing is mainly done at low temperatures, and can lead to unpleasant smells. If you have no reason to wash occasionally at high temperatures, then run a Cottons 95°C programme with detergent but no laundry at regular intervals.

### Cleaning the detergent dispenser drawer

For hygiene reasons, clean the entire drawer at regular intervals.

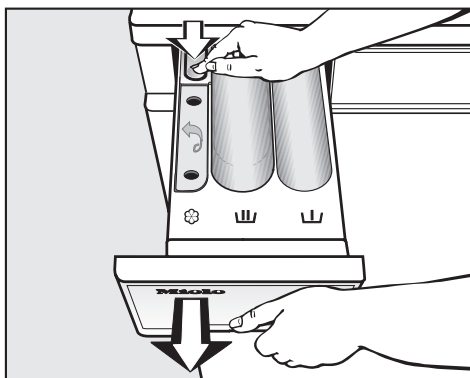

- Pull out the detergent dispenser drawer until a resistance is felt. Press down the release catch and at the same time pull the drawer right out of the machine.
- Clean the detergent drawer with hot water.



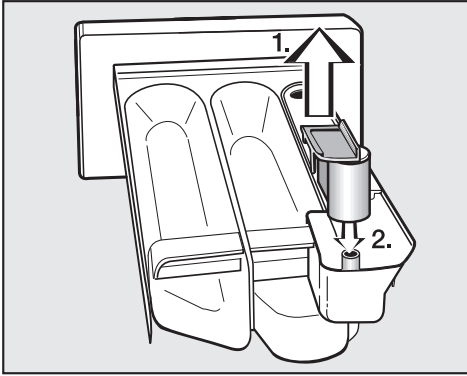

■ Clean the siphon.

1. Remove the siphon from compartment  and rinse under hot running water. Clean the siphon tube in the same way.
2. Replace the siphon.

If starching frequently, thoroughly clean the siphon and siphon tube regularly. A build-up of starch will cause them to get clogged.

## Cleaning the detergent dispenser drawer housing

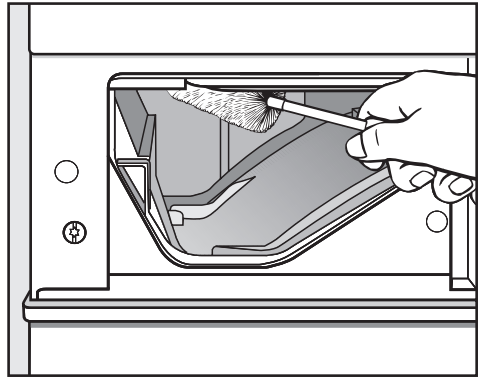

- Use a bottle brush to remove detergent residues and limescale from the jets inside the detergent dispenser drawer housing.

# Cleaning and care

## Cleaning the water inlet filters

The washing machine has two filters to protect the inlet valves.

These filters should be checked every six months or so, or more often if there are frequent interruptions to the water supply.

### To clean the filter in the union in the open end of the inlet hose:

- First turn off the stopcock.
- Unscrew the threaded union connecting the free end of the inlet hose to the stopcock.

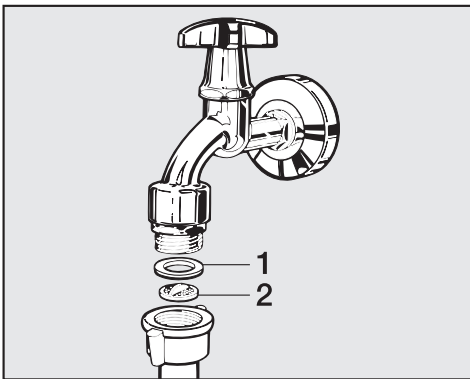

- Remove rubber seal **1** from the recess.
- Using pointed pliers, take hold of plastic filter bar **2**, remove the filter and clean it.
- Put the filter and seal back in the reverse order and reconnect the hose.
- Turn on the stopcock and check the connection is watertight. If it leaks, tighten the connection.

### To clean the filter in the water inlet valve:

- Using pliers, carefully loosen the ribbed plastic nut on the inlet valve and unscrew.

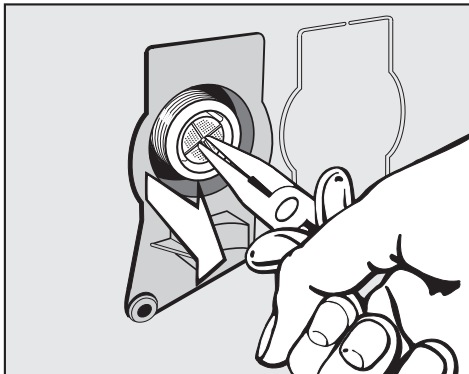

- Use pointed nose pliers to withdraw the plastic filter by the bar (see illustration). Clean, put back and secure.

The two filters **must** be put back in place after cleaning.

## Problem solving guide

With the help of the following notes minor faults in the performance of the machine, some of which may result from incorrect operation, can be put right without contacting the Service Department.

 Repair work to electrical appliances should only be carried out by a suitably qualified person in strict accordance with local and national safety regulations. Repairs and other work by unqualified persons could be dangerous. The manufacturer cannot be held liable for unauthorised work.

### The programme does not start

Problem	Possible cause	Remedy
<b>The <i>Anti-crease/Finish</i> indicator light is not on, or the indicator light for the <i>Start</i> button is not flashing.</b>	There is no power to the machine.	Check whether <ul style="list-style-type: none"><li>– the mains plug is plugged in and switched on.</li><li>– the fuse or circuit breaker has tripped.</li><li>– the drum door is closed properly.</li></ul>

## Problem solving guide

<b>The wash programme stops and a fault indicator light comes on.</b>		
<b>Fault indicator</b>	<b>Possible cause</b>	<b>Remedy ❶</b>
<b>The <i>Check drain</i> light flashes. "-- --" appears in the display.</b>	The water outlet is blocked.	Clean the drain filter and the drain pump as described in "Problem solving guide - Opening the drum door in the event of a blocked drain outlet and/or power failure".
	The drain hose has been fixed too high.	The maximum delivery head is 1 m.
<b>The <i>Check inlet</i> light flashes. "-- --" appears in the display.</b>	The water inlet is blocked.	Open the stopcock.
	The filter in the water inlet hose is dirty.	Clean the filter.
<b>The <i>Check inlet</i> and <i>Check drain</i> lights are flashing. "-- --" appears in the display.</b>	The water protection system has reacted.	Call the Service Department.
<b>The <i>Soak/Pre-wash</i> or <i>Rinses</i> indicator light is flashing. "-- --" appears in the display.</b>	There is a fault.	Start the programme again. If the fault indicator occurs again, contact the Service Department.

- ❶ To switch off the fault indicator: switch the washing machine off with the *I-On/O-Off* button and turn the programme selector to  *Finish*.

### A fault indicator light comes on but the wash programme continues as normal.

Fault indicator	Possible cause	Remedy ❶
<b>The <i>Check drain</i> light flashes.</b>	The drain outlet is restricted.	Clean the drain filter and the drain pump as described in "Problem solving guide - Opening the drum door in the event of a blocked drain outlet and/or power failure".
<b>The <i>Check inlet</i> light flashes.</b>	The water inlet is restricted.	Check whether <ul style="list-style-type: none"> <li>– the stopcock is opened wide enough.</li> <li>– the inlet hose is kinked.</li> </ul>
	The filter in the water inlet hose is dirty.	Clean the filter.
<b>The <i>Excess detergent</i> check light comes on.</b>	Excessive foam has built up during washing.	Use less detergent next time and follow the manufacturer's instructions on dosage given on the packaging.
<b>The <i>Main wash</i> indicator light is flashing.</b>	There is a fault.	Start the programme again. If the fault indicator occurs again, contact the Service Department.
<b>The <i>Anti-crease/Finish</i> indicator light is flashing.</b>	The position of the programme selector was altered after the start of the programme. Turn the programme selector back to the programme previously chosen.	

- ❶ To switch off the fault indicator: switch the washing machine off with the *I-On/O-Off* button and turn the programme selector to  *Finish*.

## Problem solving guide

General problems		
Problem	Possible cause	Remedy
<b>The machine shakes during the spin cycle.</b>	The machine feet are not level.	Level the machine (see "Installation and connection").
<b>The laundry has not been spun properly and is still wet.</b>	The machine detected an imbalance during the final spin and reduced the spin speed automatically.	Include both large and small items in the load as this will give better distribution.
<b>The laundry has not been spun satisfactorily.</b>	The spin speed selected was too low.	Select a higher spin speed next time.
<b>The pump makes strange noises.</b>	This is not a fault! These noises occur at the end of a pump sequence as a normal part of the operation.	
<b>There is a lot of detergent residue in the detergent drawer.</b>	The water pressure is too low.	<ul style="list-style-type: none"> <li>– Clean the filter in the water inlet.</li> <li>– Select Water plus.</li> </ul>
	Powder detergent used with water softeners can be sticky.	<ul style="list-style-type: none"> <li>– Clean the detergent drawer.</li> <li>– Add washing powder and then add the water softener.</li> </ul>
<b>Fabric conditioner is not completely dispensed or too much water remains in the  compartment.</b>	The siphon tube is not correctly positioned or is clogged up.	Clean the siphon, (see "Cleaning and care - Cleaning the detergent dispenser drawer").
<b>When laundry is dry it feels hard to the touch.</b>	Too vigorous wash action.	Programme in gentle action and more water.
	Not enough detergent used.	Increase detergent dose to prevent limescale build up in laundry.
	No fabric conditioner used.	Use fabric conditioner in last rinse.

<b>An unsatisfactory wash result</b>		
<b>Problem</b>	<b>Possible cause</b>	<b>Remedy</b>
<b>Liquid detergent does not give the required result.</b>	Liquid detergents usually contain no bleaching agents. They do not remove fruit, coffee and tea stains.	<ul style="list-style-type: none"> <li>– Use a general purpose detergent containing a bleaching agent.</li> <li>– Pour stain removers into compartment  of the dispenser drawer and liquid detergent into a dispenser ball.</li> <li>– Never put stain removers and liquid detergent together in the dispenser drawer.</li> </ul>
<b>Grey, greasy particles cling to washed laundry.</b>	Insufficient amounts of detergent were used to break down the particles of grease in heavily soiled laundry.	<ul style="list-style-type: none"> <li>– Use more detergent.</li> <li>– Before washing the next load run a <i>Cottons 95°C</i> programme with powder detergent but without a load.</li> </ul>
<b>A stale smell is in the drum and on laundry.</b>	Low temperature washing.	<ul style="list-style-type: none"> <li>– Before washing the next load run a <i>Cottons 95°C</i> programme with powder detergent but without a load.</li> </ul>
<b>White residues which look like powder detergent are seen on dark textiles after washing.</b>	The detergent contained compounds (zeolites) to aid water softening which are not soluble in water. They have ended up on the laundry.	<ul style="list-style-type: none"> <li>– Try and brush off the residues with a soft brush once the laundry is dry.</li> <li>– Wash dark textiles using a detergent which contains no zeolites. Liquid detergents usually contain no zeolites.</li> <li>– Use the <i>Dark garments</i> programme.</li> </ul>
<b>Clothes are coming out creased.</b>	The machine was overloaded.	<ul style="list-style-type: none"> <li>– Reduce quantity of clothes in drum.</li> </ul>
	The wrong programme was used.	<ul style="list-style-type: none"> <li>– Check care labels and the programme chart.</li> <li>– Use easy iron conditioners.</li> </ul>

## Problem solving guide

---

<b>The drum door does not open when you press the Door button</b>	
<b>Possible cause</b>	<b>Remedy</b>
<b>The machine is not connected to the electricity supply and / or is not switched on.</b>	Insert the plug in the socket and switch on and / or switch the machine on with the <i>I-On/O-Off</i> button.
<b>Power cut.</b>	Open the drum door as described in "Opening the drum door in the event of a blocked drain outlet and/or power failure".
<b>The door was not correctly engaged.</b>	Press hard against the lock side of the drum door and then press the <i>Door</i> button.
<b>There is still water in the drum and the machine is unable to drain.</b>	Clean the drain filter and the drain pump as described in the next section.
For safety reasons the drum door cannot be opened if the suds temperature is higher than 55°C.	



### Opening the drum door in the event of a blocked drain outlet and/or power failure

- Switch the washing machine off.

There is a lever behind the detergent drawer fascia panel.

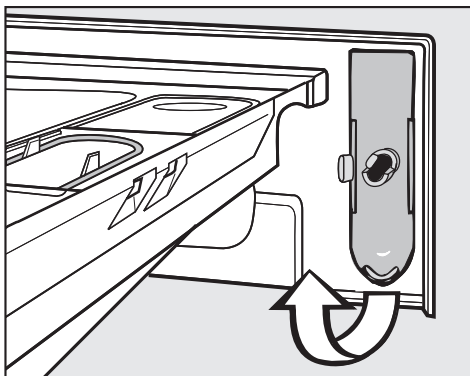

- Remove the lever.

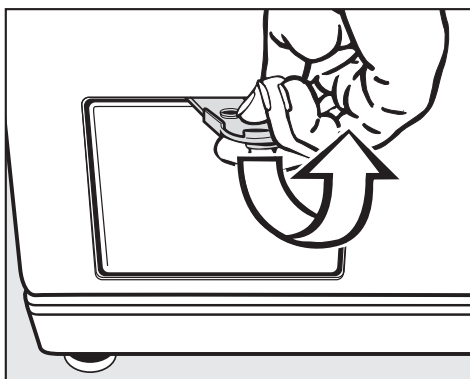

- Use it to open the access flap.

### Blocked drain outlet

If the drain outlet is blocked, up to 25 litres of water will be retained in the machine.

 **Caution:** if laundry has been washed at a high temperature, water draining out of the machine will still be hot. Danger of scalding!

### Procedure for draining the machine

Be careful not to release too much water at once. If the flow of water is too strong, some water can seep into the washing machine base and activate the water protection system float switch. This will prevent the washing machine from functioning.

- Place a suitable container under the access flap.

When draining water from the machine, do **not** unscrew the drain filter completely or take it right out.



- Slowly and carefully unscrew the drain filter to let the water out.

If you need to interrupt the flow of water:

- Tighten the drain filter back up again.

## Problem solving guide

Once the flow of water ceases:

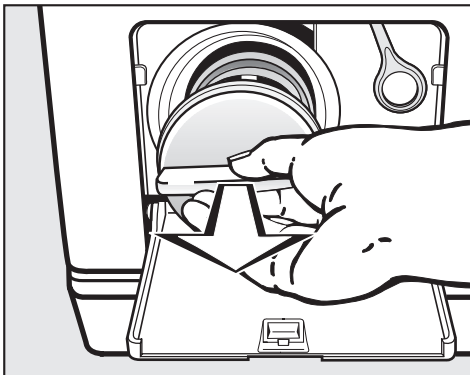

- Remove the drain filter completely.
- Clean it thoroughly.

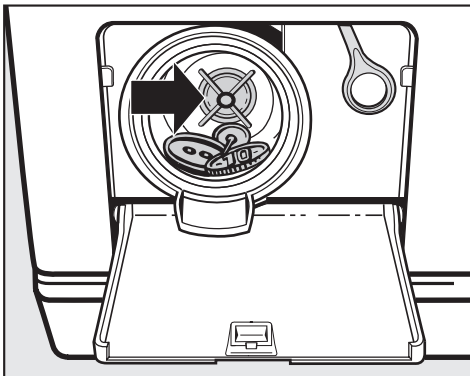

- Remove any foreign objects (e.g. buttons, coins, etc.) and fluff from the filter housing. Turn the impeller by hand to check that it rotates freely. Any foreign object causing an obstruction should be removed.
- Put the drain filter back in place and secure.

 Make sure the drain filter is securely tightened. Otherwise there is a risk of water leakage during use.

To avoid loss of detergent, pour approx. 2 litres of water into the detergent dispenser drawer after cleaning the drain filter. Excess water will be pumped out automatically before the next wash programme.

### Opening the drum door

 Always make sure that the drum is stationary before reaching into the machine to remove laundry. Reaching into a moving drum is extremely dangerous.

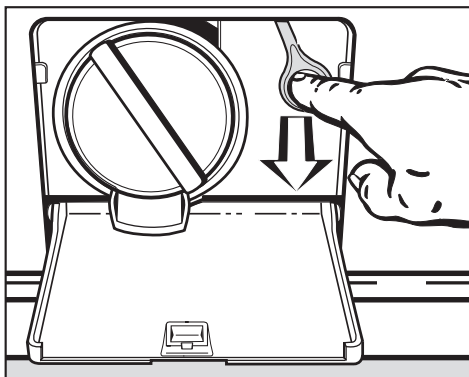

- Pull the emergency release downwards (see illustration). The drum door will open.

In the event of any faults which you cannot remedy yourself, please contact:

- your Miele Dealer or
- Miele (see back cover for contact details).

When contacting your Dealer or Miele, please quote the model and serial number of your machine, both of which are shown on the data plate visible above the porthole glass when the door is open.

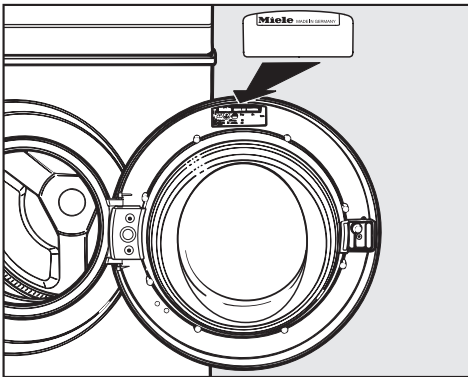

N.B. A call-out charge will be applied for service visits where the problem could have been resolved as described in these instructions.

### Future updates (PC)

The indicator light marked PC is the interface used by Miele service technicians during servicing work for testing purposes and for updating the machine's programme data.

### Guarantee

For information on the appliance guarantee specific to your country please contact Miele. See back cover for contact details.

In the U.K. your appliance is guaranteed for 2 years from the date of purchase. However, you must activate your cover by calling 0845 365 6640 or registering online at [www.miele.co.uk](http://www.miele.co.uk).

### Optional spare parts and accessories

Optional spare parts and accessories for this washing machine are available from your Miele Dealer, the Miele Spare Parts Department or via the internet at [www.miele-shop.com](http://www.miele-shop.com).

Please note that telephone calls may be monitored and recorded for training purposes.

# Installation and connection

## Front view

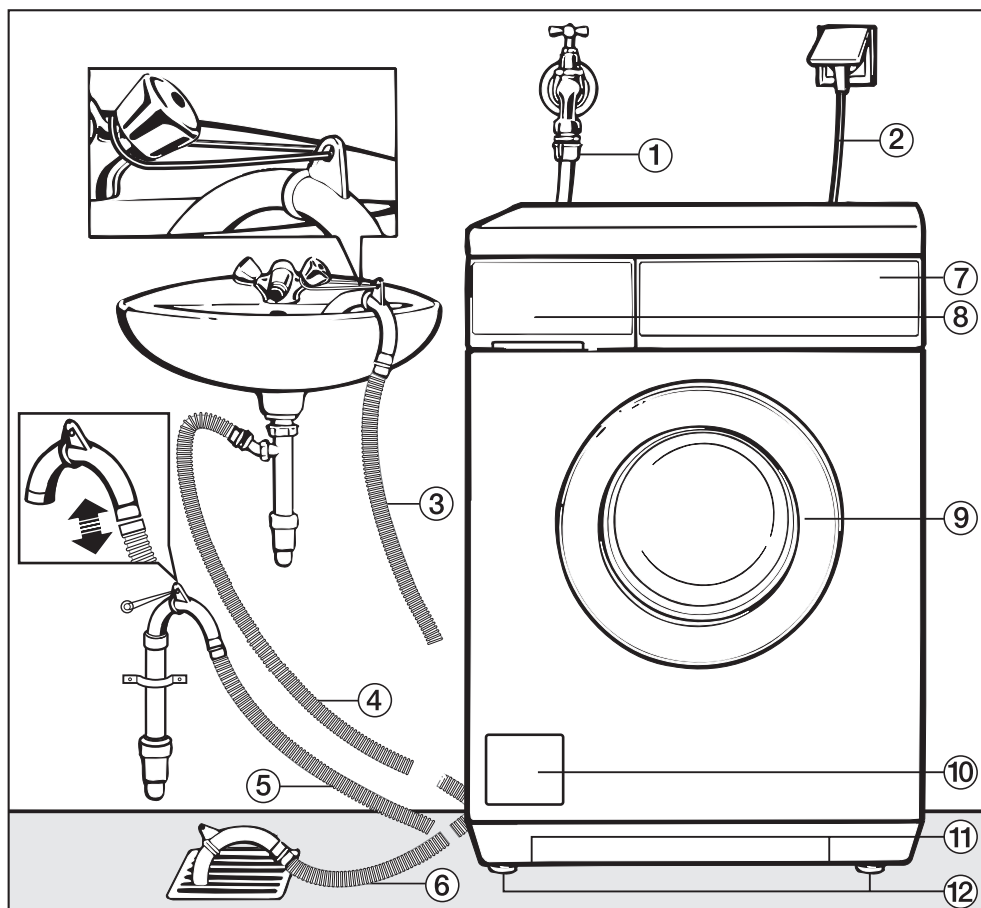

① Inlet hose (tested to withstand pressure of at least 7,000 kPa)

② Electricity supply cable

③ - ⑥ Flexible drain hose (with detachable swivel elbow)

⑦ Control panel

⑧ Detergent dispenser drawer

⑨ Drum door

⑩ Access to drain filter, drain pump and emergency release

⑪ Handle recesses for moving the machine

⑫ Four height adjustable feet

## Rear view

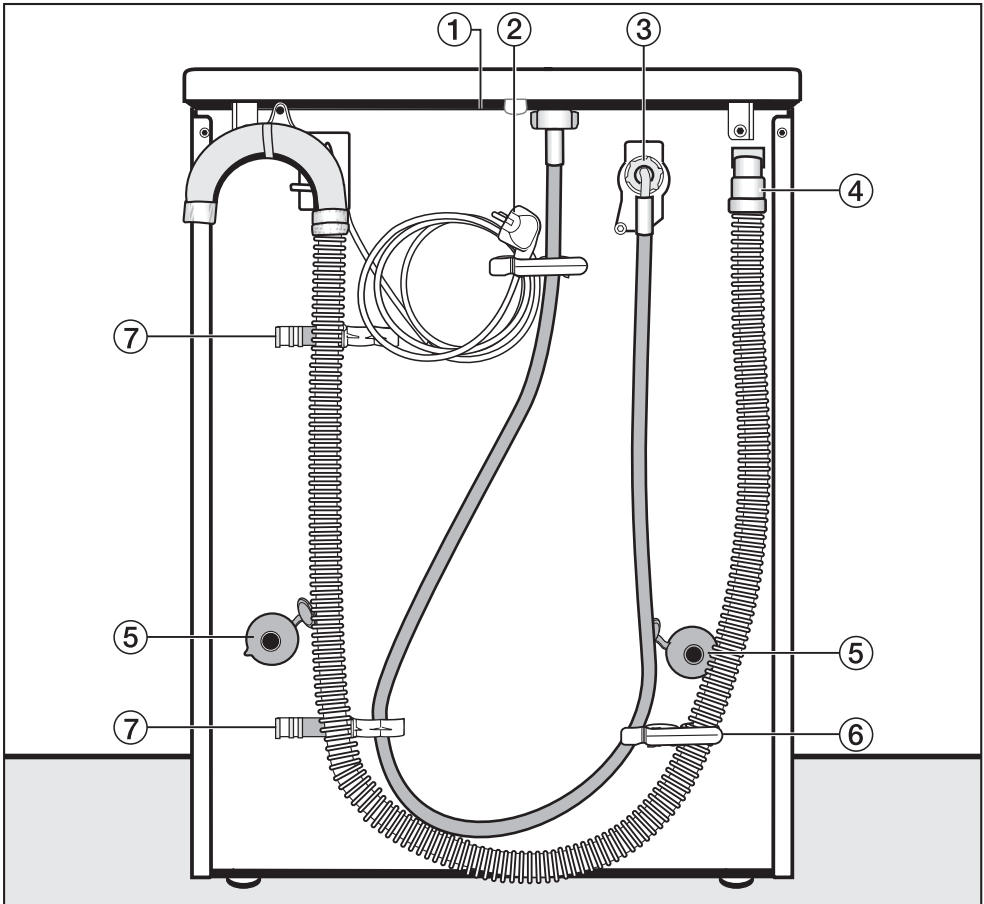

- ① Protruding lid for holding when moving the machine
- ② Electricity supply cable
- ③ Inlet hose (tested to withstand pressure of at least 7,000 kPa)
- ④ Drain hose

- ⑤ Transit bar covers
- ⑥ Restraining clip for inlet hose and drain hose
- ⑦ Restraining clips for transit bars when removed

# Installation and connection

## Installation surface

A concrete floor is the most suitable installation surface for a washing machine, being far less prone to vibration during the spin cycle than wooden floorboards or a carpeted surface.

Please note the following points:

- The machine must be level and securely positioned.
- To avoid vibrations during spinning, the machine should not be installed on soft floor coverings.

If installing on a wooden joist floor:

- We recommend a plywood base (at least 59x52x3 cm). The base should span several joists and be bolted to the joists and not only to the floorboards. Check for the presence of pipes and cables.

If possible, install the machine in a corner, as this is usually the most stable part of the floor.

⚠ If the machine is installed on a raised plinth, it **has to be secured** against slippage during spinning using retaining clips (available from the Miele Spare Parts Dept). Otherwise there is a danger of the machine moving and falling off the plinth.

## Installing the washing machine

To manoeuvre the machine out of its packing case to its installation site hold it by the edge of the lid where it protrudes to the rear of the washing machine as well as by the handle recesses at the front.

⚠ Ensure that the machine feet and the floor are dry to prevent the machine from slipping during the spin cycle.

## Removing the transit bars

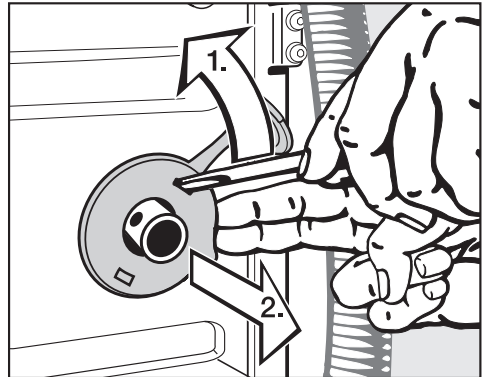

- To remove the left and right covers
  1. Use a screwdriver to prise out the cover as illustrated.
  2. Pull the cover forwards to remove.

## Installation and connection

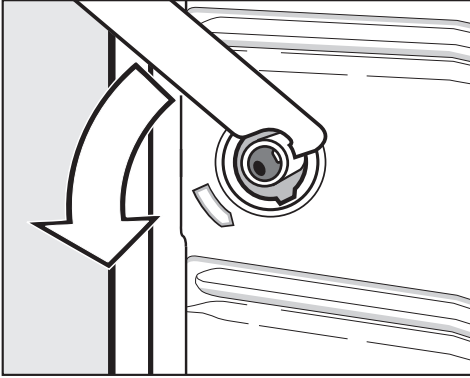

- Using the spanner supplied turn the left-hand transit bar 90°, then

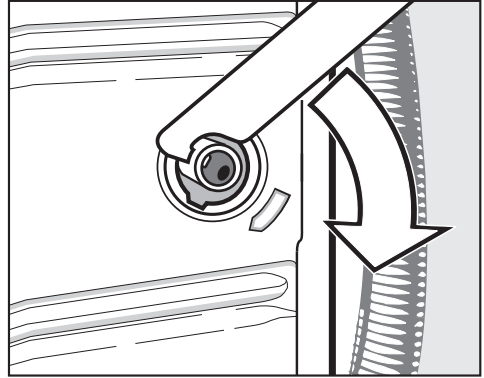

- Turn the right-hand transit bar 90°, then

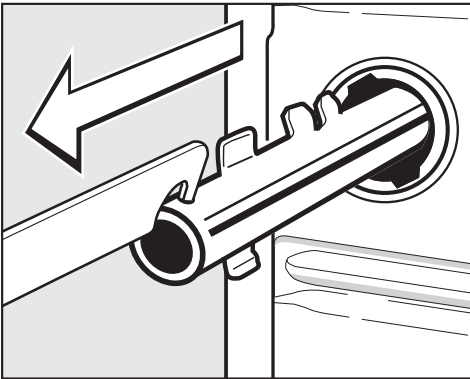

- withdraw the transit bar.

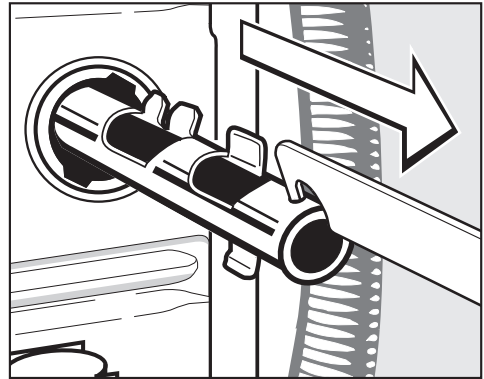

- withdraw the transit bar.

## Installation and connection

 To avoid the risk of injury the holes for the transit bars must be covered after the transit bars have been removed.

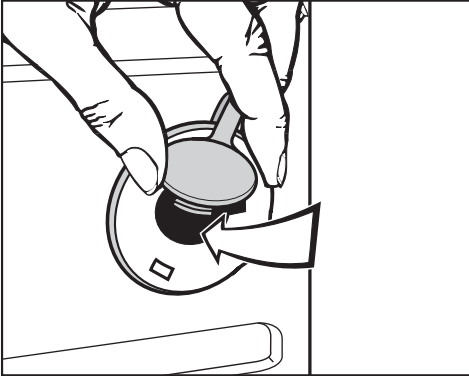

- Fit the covers on to the two holes. Then plug the holes as shown with the caps.

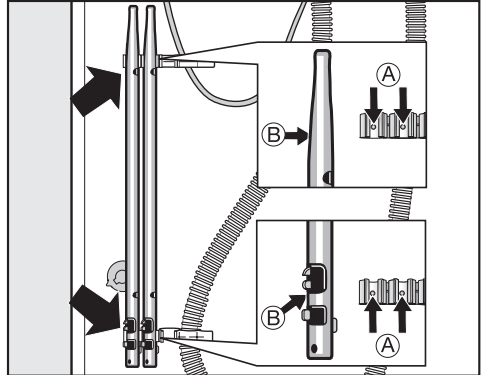

- Secure the transit bars to the back of the washing machine. Make sure that holes **B** are fitted over retainers **A**.

 The washing machine must not be moved without the transit bars in place. Store them in a safe place for future use. They must be re-fitted if the machine is to be moved again (e.g. when moving house).

### Re-fitting the transit bars

Re-fitting is carried out by reversing the procedure.



## Levelling the machine

The machine must stand perfectly level on all four feet to ensure safe and proper operation.

Incorrect installation may increase electricity and water consumption and may cause the machine to move about.

## Screwing out and adjusting the feet

The four adjustable screw feet are used to level the machine. All four feet are screwed in when the machine is delivered.

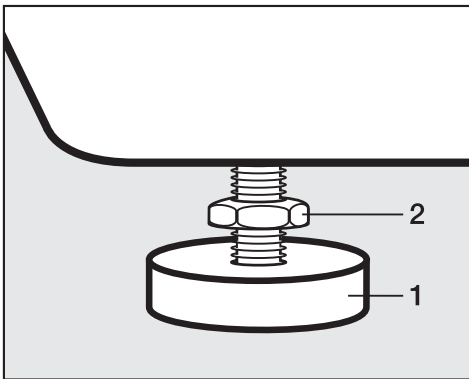

- Using the spanner supplied turn counternut **2** in a clockwise direction. Then turn counternut **2** together with foot **1** to unscrew.

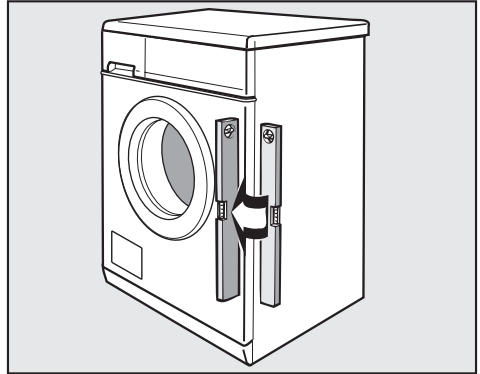

- Use a spirit level to check the machine is standing level.
- Hold foot **1** securely with a pipe wrench. Turn counternut **2** again using the spanner supplied until it sits firmly up against the housing.

 All four counternuts must be firmly up against the housing. Please also check this for the feet which did not need adjustment. Otherwise there is the danger of the machine moving about.

# Installation and connection

The fitting of building-under kits\* and stacking kits\* must only be undertaken by qualified and competent persons, in accordance with the instructions supplied with the kit.

## Building under a continuous worktop/in a kitchen run

If you wish to push your machine under a worktop and there is space to do this **without removing the lid**, the conversion kit is not necessary. Otherwise the conversion kit is essential.

- A special building-under conversion kit\* is required.  
To ensure electrical safety, the washing machine lid must be replaced by the cover plate supplied with the conversion kit.
- For installation under a work surface 900/910 mm from the floor, a raising kit\* is required.
- Connections for electricity, water and drainage should be installed in such a way that they remain accessible when the machine is in place.

Fitting instructions are supplied with the conversion kit.

All parts marked\* are available from your Dealer, the Miele Spare Parts Department or via the internet at [www.miele-shop.com](http://www.miele-shop.com).

## Washer and Dryer stack

A Miele tumble dryer can be stacked with the washing machine. A "WTV" stacking kit\* is necessary.

### Please note:

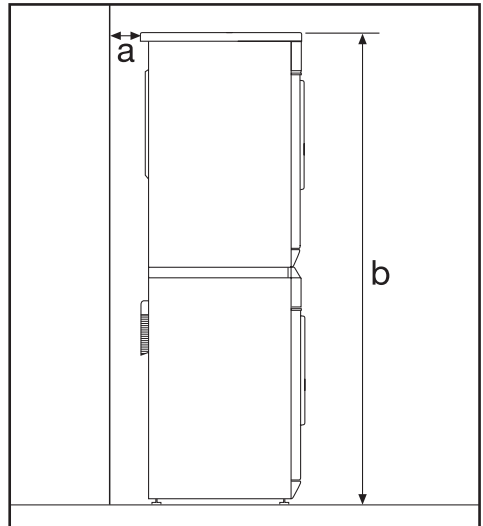

**a** Safety distance to wall:  
at least 2 cm

**b** Height:  
Stacking kit with pull-out shelf:  
approx. 169 cm  
Stacking kit without pull-out shelf:  
approx. 170 cm

## The Miele water protection system

The Miele water protection system protects the washing machine from water damage.

The system consists of three main components:

- 1) the inlet hose
- 2) the electronic unit and the washing machine housing
- 3) the drain hose

### 1) Inlet hose

The inlet hose is tested to withstand pressure of more than 7,000 kPa.

### 2) Electronic unit and washing machine housing

- Sump

Any leaking water is collected in a sump in the base of the machine. A float switches off the safety valves, preventing any more water flowing into the machine and water in the suds container is pumped away.

- Overflow protection

This prevents the washing machine taking in too much water. If the water level exceeds a certain level, the drain pump switches in and pumps the excess water away.

### 3) Drain hose

The drain hose is protected by a ventilation system which prevents the washing machine from being emptied completely.

# Installation and connection

---

## Connection to the water supply

The machine should be connected to a mains water supply in accordance with local and national safety regulations. The German authorities do not require it to have a non-return valve as the washing machine has been designed to comply with DIN regulations.

The machine is designed to operate with a flow pressure of between 100 kPa and 1,000 kPa. If it is higher than 1,000 kPa it is essential to fit a pressure reducing valve.

Connection to the mains water supply should incorporate a mains stopcock with  $\frac{3}{4}$ " thread. The stopcock should be fitted by a qualified plumber.

In order to protect the water inlet valve, the two dirt filters - one in the open end of the inlet hose, one at the inlet point in the machine - must not be removed.

## Extension hose

- Longer hoses 2.5 or 4.0 m in length are available from your Miele dealer or the Miele Spare Parts Department as optional extras.

 The connection point is subject to mains water pressure. Turn on the stopcock slowly and check for leaks. Correct the position of the washer and union if appropriate.

The washing machine is **not** suitable for connection to a hot water supply.

## Maintenance and care

Only use a genuine Miele hose should you ever need a replacement or extension. These are tested to withstand pressure of at least 7,000 kPa.

## Connection to the drainage system

The machine drains via a drain pump with a delivery head of 1 metre\*. The drain hose must not be kinked as this restricts drainage. The swivel elbow at the end of the hose can be turned in either direction, or can be detached if required, with a sharp twist and pull.

If required, the drain hose can be extended to a length of 5 m. The necessary parts can be purchased from the Miele Spare Parts Department or your Miele dealer.

\* For a delivery head of more than 1 m (up to a max. of 1.8 m) a replacement drain pump will need to be fitted. Please contact the Miele Spare Parts Department or your Miele Dealer.

### Drain hose connection:

1. Direct into a sink or basin:

Please note the following:

- Hook the hose over the edge and secure.
  - Make sure that the water can drain away freely without hindrance. Otherwise there is a risk of water overflowing or of some of the drained water being sucked back into the machine.
2. Connected securely to a plastic drain pipe with a rubber nipple. There is no need to use a non-return valve.
  3. Connected securely to a standpipe.
  4. Connected securely to a floor gully.

Please note:

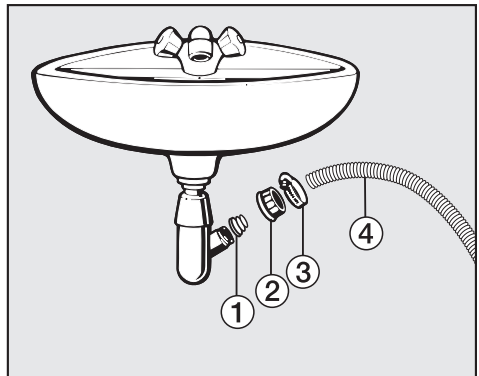

① Adapter

② Nut

③ Hose clip

④ End of the hose

- Fit adapter ① to the sink drain outlet using nut ②.
- Attach the end of the hose ④ to adapter ①.
- Use a screwdriver to tighten hose clip ③ up close to the nut.

# Installation and connection

---

## Electrical connection U.K.

All electrical work should be carried out by a suitably qualified and competent person, in strict accordance with current national and local safety regulations (BS 7671 in the UK).

Ensure power is not supplied to the appliance until after installation work has been carried out.

The appliance is supplied with a mains cable with moulded plug ready for connection to a 230-240V mains supply.

Please ensure the connection data quoted on the data plate match the household mains supply.

Connection should be made via a suitable switched socket which is easily accessible after installation.

For extra safety it is advisable to protect the machine with a suitable residual current device (RCD). Contact a qualified electrician for advice.

Do not connect via an extension lead. Extension leads do not guarantee the required safety of the appliance (e.g. danger of overheating).



## Non-rewireable plugs BS 1363

The fuse cover must be refitted when changing the fuse, and if the fuse cover is lost, the plug must not be used until a suitable replacement is obtained. The colour of the correct replacement cover is that of the coloured insert in the base of the plug, or the colour that is embossed in words on the base of the plug (as applicable to the design of plug fitted).

Replacement fuses should be ASTA approved to BS 1362 and have the correct rating. Replacement fuses and fuse covers may be purchased from your local electrical supplier.

## **WARNING: THIS APPLIANCE MUST BE EARTHED**

## Consumption data

		Load	Consumption data		
			Energy in kWh	Water in litres	Normal
<b>Cottons</b>	95°C	7.0 kg	1.99	49	2 h 09 min
	60°C*	7.0 kg	0.99	49	1 h 49 min
	60°C*	3.5 kg	0.98	40	1 h 49 min
	40°C	7.0 kg	0.75	55	1 h 49 min
	40°C*	7.0 kg	0.65	54	1 h 49 min
<b>Minimum iron</b>	40°C	3.0 kg	0.50	55	1 h 19 min
<b>Delicates</b>	30°C	2.0 kg	0.35	69	59 min
<b>Automatic</b>	40°C	3.5 kg	0.35 - 0.50	40 - 55	1 h 13 min
<b>Dark garments</b>	40°C	3.0 kg	0.60	60	1 h 13 min
<b>Shirts</b>	40°C	2.0 kg	0.50	45	56 min
<b>Denim</b>	40°C	3.0 kg	0.50	52	1 h 00 min
<b>Express</b>	40°C	3.0 kg	0.30	34	30 min
<b>Silks</b> 	30°C	1.0 kg	0.25	39	36 min
<b>Woolens</b> 	30°C	2.0 kg	0.23	39	40 min

\* The test programme conforms to EN 60456 and the energy label with Directive 1061/2010.

Consumption data can vary from the nominal values given depending on water pressure, water hardness, water inlet temperature, room temperature, type and volume of load, fluctuations in the electricity supply and any additional options selected.

## Technical data

---

Height	850 mm
Width	595 mm
Depth	580 mm
Depth with door open	975 mm
Height for building under	820 mm
Width for building under	600 mm
Depth for building under	600 mm
Weight	98 kg
Capacity	7 kg dry laundry
Voltage	see data plate
Connected load	see data plate
Fuse rating (UK)	see data plate / plug
Consumption data	see "Consumption data"
Water flow pressure min.	100 kPa (1 bar)
Water flow pressure max.	1,000 kPa (10 bar)
Inlet hose length	1.60 m
Drain hose length	1.50 m
Mains connection cable length	1.60 m
Delivery head max.	1.00 m
Maximum drainage length	5.00 m
Test certificates awarded	see data plate



## Programmable functions for changing default settings

The programmable functions can be used to tailor washing programmes to suit your individual requirements.

# Programmable functions

## Water plus system

This is used to select the water intake setting for the *Water plus* additional option.

There are four different options:

### Setting 1:

an increase in the rinse water level

### Setting 2:

an increase in the water level in the main wash and rinses (the washing machine is delivered with setting 2 programmed as standard)

### Setting 3:

an extra rinse cycle in the *Cottons* and *Minimum iron* programmes

### Setting 4:

an increase in the water level in the main wash and rinses and also an extra rinse cycle in the *Cottons* and *Minimum iron* programmes

## Follow steps ① to ⑦ to programme and store in memory.

Before you begin, first ensure that:

- The washing machine is switched off.
- The machine is properly closed.
- Make sure that the programme selector is at the  $\diamond$  *Finish* position.

① Press the *Start* button and keep it pressed in whilst carrying out steps

②-③.

② Switch the machine on with the *I-On/O-Off* button.

③ Wait until the *Start* button indicator light comes on . . .

④ . . . and then release the *Start* button.

⑤ Turn the programme selector to the *Cottons 60°C* position:

A *P* will flash in the display alternating with the number *1*, *2*, *3* or *4*.

⑥ Each subsequent press on the *Start* button selects a different setting.

The number alternating with the *P* in the display refers to the settings as follows:

*1* = Setting 1 is selected

*2* = Setting 2 is selected

*3* = Setting 3 is selected

*4* = Setting 4 is selected

⑦ Switch the machine off with the *I-On/O-Off* button.

The *Water plus* button has now been allocated the setting you have chosen. This setting will remain in memory until another setting is programmed.

## Gentle action

Activating gentle action reduces the drum action and is suitable for washing slightly soiled articles more gently.

Gentle action can be used with the *Cottons*, *Express* and *Automatic* programmes.

If Gentle action is programmed into the machine, every wash cycle in these programmes will be carried out with gentle action rhythm.

The washing machine is delivered with the Gentle action setting deactivated.

### Follow steps ① to ⑦ to programme and store in memory.

Before you begin, first ensure that:

- The washing machine is switched off.
- The machine is properly closed.
- Make sure that the programme selector is at the  $\diamond$  *Finish* position.

① Press the *Start* button and keep it pressed in whilst carrying out steps ②-③.

② Switch the machine on with the *I-On/O-Off* button.

③ Wait until the *Start* button indicator light comes on . . .

④ . . . and then release the *Start* button.

⑤ Turn the programme selector to the *Cottons 40°C* position:

A *P* will flash in the display alternating with the number *0* or *1*.

*0* = Gentle action is **deactivated**.

*1* = Gentle action is **activated**.

⑥ Press the *Start* button to change the display from *0* to *1* or from *1* to *0*.

⑦ Switch the machine off with the *I-On/O-Off* button.

The setting you have selected is now stored in memory and will remain so until you alter it.

# Programmable functions

---

## Suds cooling for Cottons

When this is activated, additional water flows into the drum at the end of the main wash to cool the suds down. Hot suds can damage plastic drainage pipes.

Suds cooling takes place when a temperature of 95°C is selected.

Suds cooling should be activated:

- to prevent the danger of scalding if the drain hose is hooked over the edge of a sink or basin.
- where the drainage pipes do not comply with DIN 1986.

The washing machine is delivered with the Suds cooling option for *Cottons* deactivated.

### Follow steps ① to ⑦ to programme and store in memory.

Before you begin, first ensure that:

- The washing machine is switched off.
- The machine is properly closed.
- Make sure that the programme selector is at the  $\diamond$  *Finish* position.

① Press the *Start* button and keep it pressed in whilst carrying out steps ②-③.

② Switch the machine on with the *I-On/O-Off* button.

③ Wait until the *Start* button indicator light comes on . . .

④ . . . and then release the *Start* button.

⑤ Turn the programme selector to the *Cottons 30°C* position:

A *P* will flash in the display alternating with the number *0* or *1*.

*0* = Suds cooling is **deactivated**.

*1* = Suds cooling is **activated**.

⑥ Press the *Start* button to change the display from *0* to *1* or from *1* to *0*.

⑦ Switch the machine off with the *I-On/O-Off* button.

The setting you have selected is now stored in memory and will remain so until you alter it.

## Memory function

If an additional option is selected for a programme, and / or the spin speed is altered, the machine stores these changes in memory at the start of a programme.

When that particular programme is chosen again, the washing machine will display the additional option(s) and / or spin speed which have been stored for that programme in the memory.

The machine is delivered with the memory function deactivated.

### Follow steps ① to ⑦ to programme and store in memory.

Before you begin, first ensure that:

- The washing machine is switched off.
- The machine is properly closed.
- Make sure that the programme selector is at the  $\diamond$  *Finish* position.

- ① Press the *Start* button and keep it pressed in whilst carrying out steps ②-③.
- ② Switch the machine on with the *I-On/O-Off* button.
- ③ Wait until the *Start* button indicator light comes on . . .
- ④ . . . and then release the *Start* button.
- ⑤ Turn the programme selector to *Minimum iron 60°C*.

A *P* will flash in the display alternating with the number  $\bar{0}$  or *1*.

$\bar{0}$  = the memory function is **deactivated**.

*1* = the memory function is **activated**.

- ⑥ Press the *Start* button to change the display from  $\bar{0}$  to *1* or from *1* to  $\bar{0}$ .
- ⑦ Switch the machine off with the *I-On/O-Off* button.

The setting you have selected is now stored in memory and will remain so until you alter it.

# Programmable functions

---

## Soak duration

A length of time of between 30 minutes and 2 hours can be programmed in 30 minute increments for the soak process.

If the Soak option is pressed, the selected soak time will be carried out for the period selected before the wash programme is run.

The machine is delivered with a two hour soak time set as standard.

### Follow steps ① to ⑦ to programme and store in memory.

Before you begin, first ensure that:

- The washing machine is switched off.
- The machine is properly closed.
- Make sure that the programme selector is at the  *Finish* position.

① Press the *Start* button and keep it pressed in whilst carrying out steps ②-③.

② Switch the machine on with the *I-On/O-Off* button.

③ Wait until the *Start* button indicator light comes on . . .

④ . . . and then release the *Start* button.

⑤ Turn the programme selector to *Minimum iron 40°C*:

A *P* will flash in the display alternating with the number 1, 2, 3 or 4.

⑥ Each subsequent press on the *Start* button selects a different setting.

The number alternating with the *P* in the display refers to the settings as follows:

1 = the soak time is 2 hours  
(default setting)

2 = the soak time is 1 hour 30 minutes

3 = the soak time is 1 hour

4 = the soak time is 30 minutes

⑦ Switch the machine off with the *I-On/O-Off* button.

The *Soak* button has now been allocated the setting you have chosen. This setting will remain in memory until another setting is programmed.

Miele washing machines offer perfect care for your laundry and feature a wide range of special programmes designed to suit the fabric being washed. Miele have also developed a range of specialist CareCollection detergents and conditioning products to offer you a complete package for cleaning and caring for your laundry.

The Miele CareCollection detergents and conditioning products are listed below. You can order these and many other useful products via the internet at:



All the products can also be ordered via the Miele Customer Contact Centre (see back cover for contact details).

### CareCollection

#### Miele specialist detergents

##### "Outdoor wear"

This specialist detergent will clean your water-repellent outerwear with care.

##### "Sportswear"

The Miele Sportswear detergent is designed to clean sportswear and remove odours whilst taking care of the special microfibres used in these garments.

##### "Down Items"

This special-purpose detergent contains a mild tenside and has been specially formulated to keep down-filled items supple and to give them bounce.

#### Miele proofing agent

This special finishing agent reproofs garments against wind and water and provides a dirt-repellent finish whilst retaining elasticity and breathability.

## Optional accessories

---

### **"UltraWhite" detergent**

This multi-purpose powder detergent has excellent stain removal properties and is suitable for white and light coloured laundry as well as heavily soiled coloured items.

### **"UltraColor" detergent for coloured garments**

This liquid detergent is particularly suitable for cleaning coloured and dark garments. The special formulation offers effective stain removal, even at low temperatures, while helping to prevent colours fading.

### **Liquid detergent "For Delicates"**

This liquid detergent is ideal for the gentle treatment of delicate fabrics, such as wool and silk. Its special formulation cleans effectively at temperatures as low as 20°C, while protecting the colour of your delicate garments.

### **Fabric conditioner**

The Miele fabric conditioner will give your laundry a fresh, natural fragrance. It makes garments soft to handle and prevents static build-up during tumble drying.









## United Kingdom

Miele Co. Ltd.  
Fairacres, Marcham Road  
Abingdon, Oxon, OX14 1TW  
Tel: 0845 365 0555  
Fax: 0845 365 0777  
Customer Contact Centre Tel: 0845 365 6600  
E-mail: [info@miele.co.uk](mailto:info@miele.co.uk)  
Internet: [www.miele.co.uk](http://www.miele.co.uk)

## Australia

Miele Australia Pty. Ltd.  
ABN 96 005 635 398  
1 Gilbert Park Drive, Knoxfield, VIC 3180  
Tel: 1300 464 353, Fax: (03) 9764 7149  
Internet: [www.miele.com.au](http://www.miele.com.au)

## China

Miele (Shanghai) Trading Ltd.  
1-3 Floor, No. 82 Shi Men Yi Road  
Jing' an District  
200040 Shanghai, PRC  
Tel: +86 21 6157 3500  
Fax: +86 21 6157 3511  
E-mail: [mieleshanghai@cn.miele.com](mailto:mieleshanghai@cn.miele.com)  
Internet: [www.miele.cn](http://www.miele.cn)

## Miele (Hong Kong) Limited

41/F - 4101, Manhattan Place  
23 Wang Tai Road  
Kowloon Bay  
Hong Kong  
Tel: (852) 2610 1331  
Fax: (852) 2610 1013  
Email: [mielehk@miele.com.hk](mailto:mielehk@miele.com.hk)

## India

Miele India Pvt. Ltd.  
Ground Floor, Copia Corporate Suites  
Plot No. 9, Jasola  
New Delhi - 110025  
Tel: 011-46 900 000, Fax: 011-46 900 001  
E-mail: [customercare@miele.in](mailto:customercare@miele.in)  
Internet: [www.miele.in](http://www.miele.in)

**Manufacturer:** Germany - Miele & Cie. KG  
Carl-Miele-Straße 29, 33332 Gütersloh

# Miele

## Ireland

Miele Ireland Ltd.  
2024 Bianconi Avenue  
Citywest Business Campus, Dublin 24  
Tel: (01) 461 07 10, Fax: (01) 461 07 97  
E-Mail: [info@miele.ie](mailto:info@miele.ie), Internet: [www.miele.ie](http://www.miele.ie)

## New Zealand

Miele New Zealand Limited  
Unit L, 10-20 Sylvia Park Road  
Mt. Wellington, 1060, Auckland, NZ  
Tel: 0800 264 353, Fax: 0800 463 453  
Internet: [www.miele.co.nz](http://www.miele.co.nz)

## Singapore

Miele Southeast Asia  
Miele Pte. Ltd.  
163 Penang Road  
# 04 - 02/03 Winsland House II  
Singapore 238463  
Tel: +65 6735 1191, Fax: +65 6735 1161  
E-Mail: [infosea@miele.com.sg](mailto:infosea@miele.com.sg)  
Internet: [www.miele.sg](http://www.miele.sg)

## South Africa

Miele (Pty) Ltd  
63 Peter Place, Bryanston 2194  
P.O. Box 69434, Bryanston 2021  
Tel: +27 (0) 11 548-1900  
Fax: +27 (0) 11 548-1935  
E-mail: [info@miele.co.za](mailto:info@miele.co.za)  
Internet: [www.miele.co.za](http://www.miele.co.za)

## United Arab Emirates

Miele Appliances Ltd.  
P.O. Box 11 47 82  
Gold & Diamond Park  
Sheikh Zayed Road  
Building 6 / Offices Nos. 6-214 to 6-220  
Dubai  
Tel: +971-4-341 84 44  
Fax: +971-4-341 88 52  
E-Mail: [info@miele.ae](mailto:info@miele.ae)  
Internet: [www.miele.ae](http://www.miele.ae)